

Här planerar vi att bygga ca 40 villor och lägenheter



arkitektbyrå ab  
iwald åkerblad

Lämna intresseanmälan på [www.skummeslovsgarden.se](http://www.skummeslovsgarden.se)

# hus A

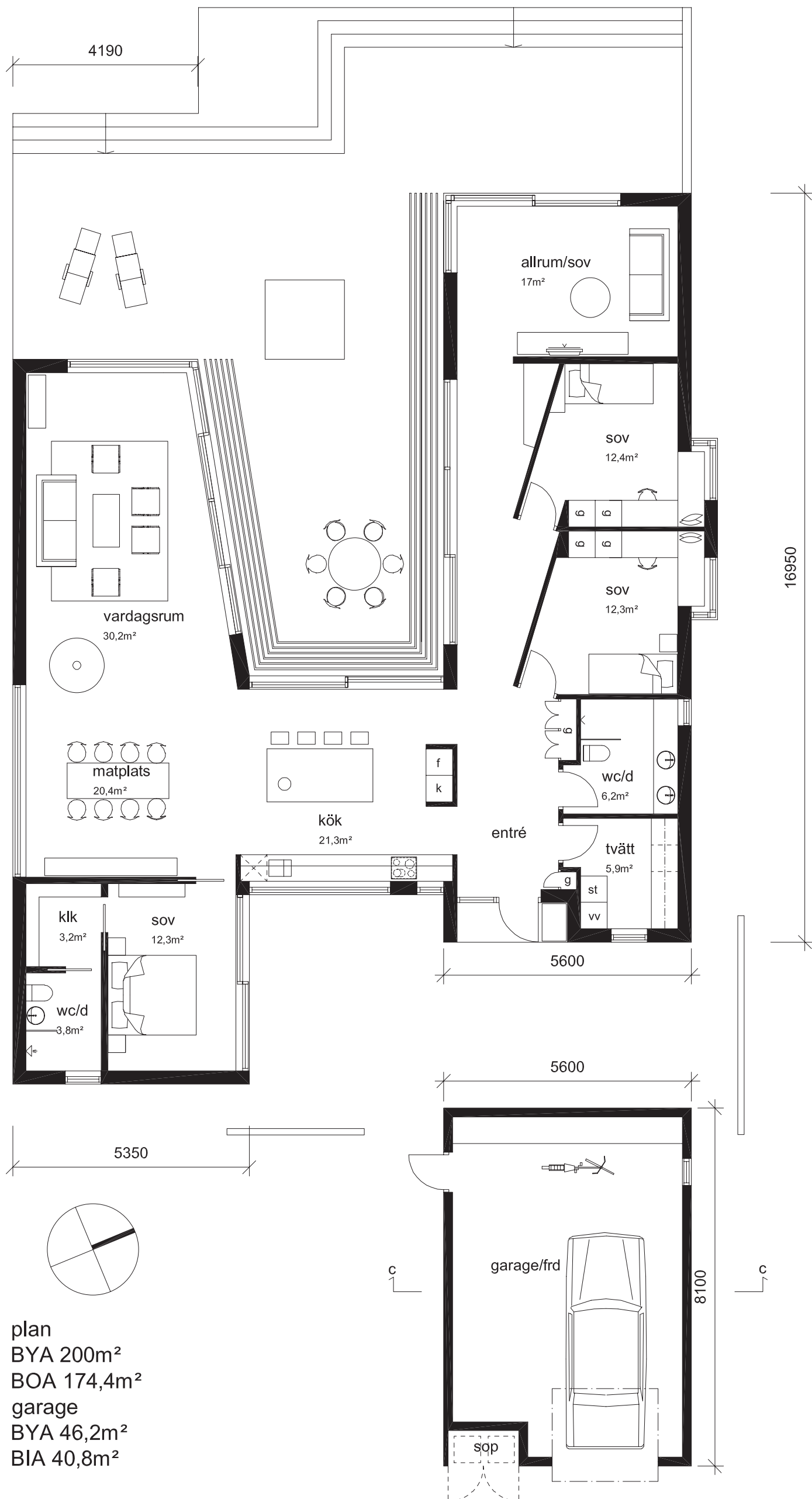

plan  
 BYA 200m<sup>2</sup>  
 BOA 174,4m<sup>2</sup>  
 garage  
 BYA 46,2m<sup>2</sup>  
 BIA 40,8m<sup>2</sup>

# hus A

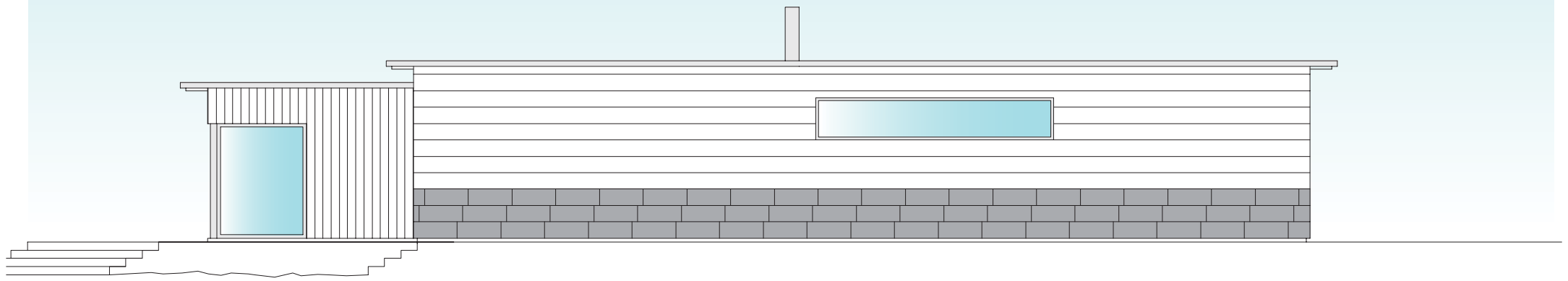

fasad mot söder

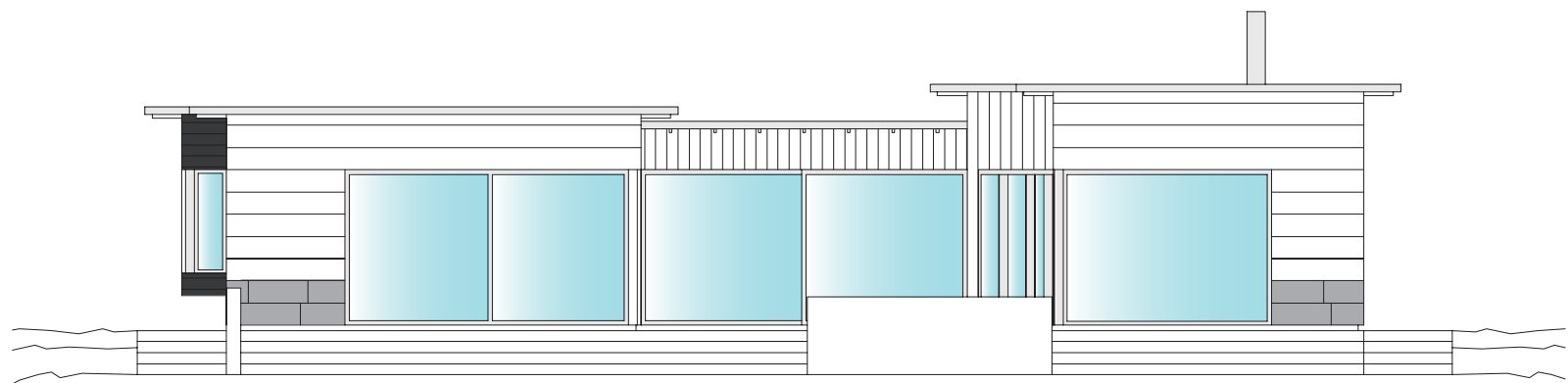

fasad mot väster

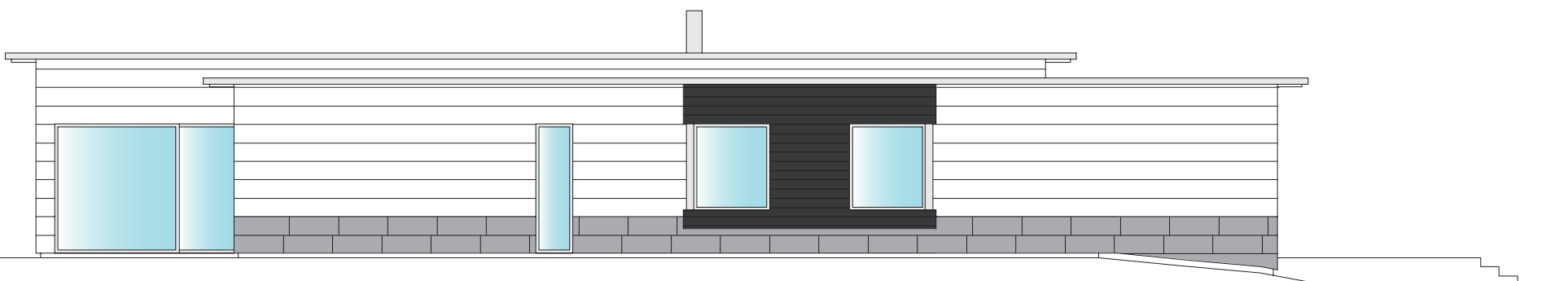

fasad mot norr

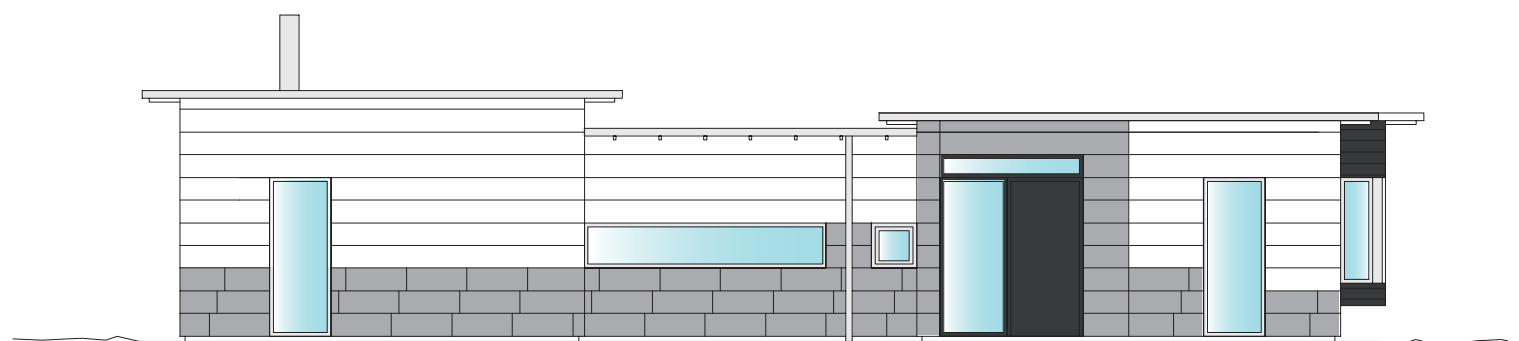

fasad mot öster

# hus B

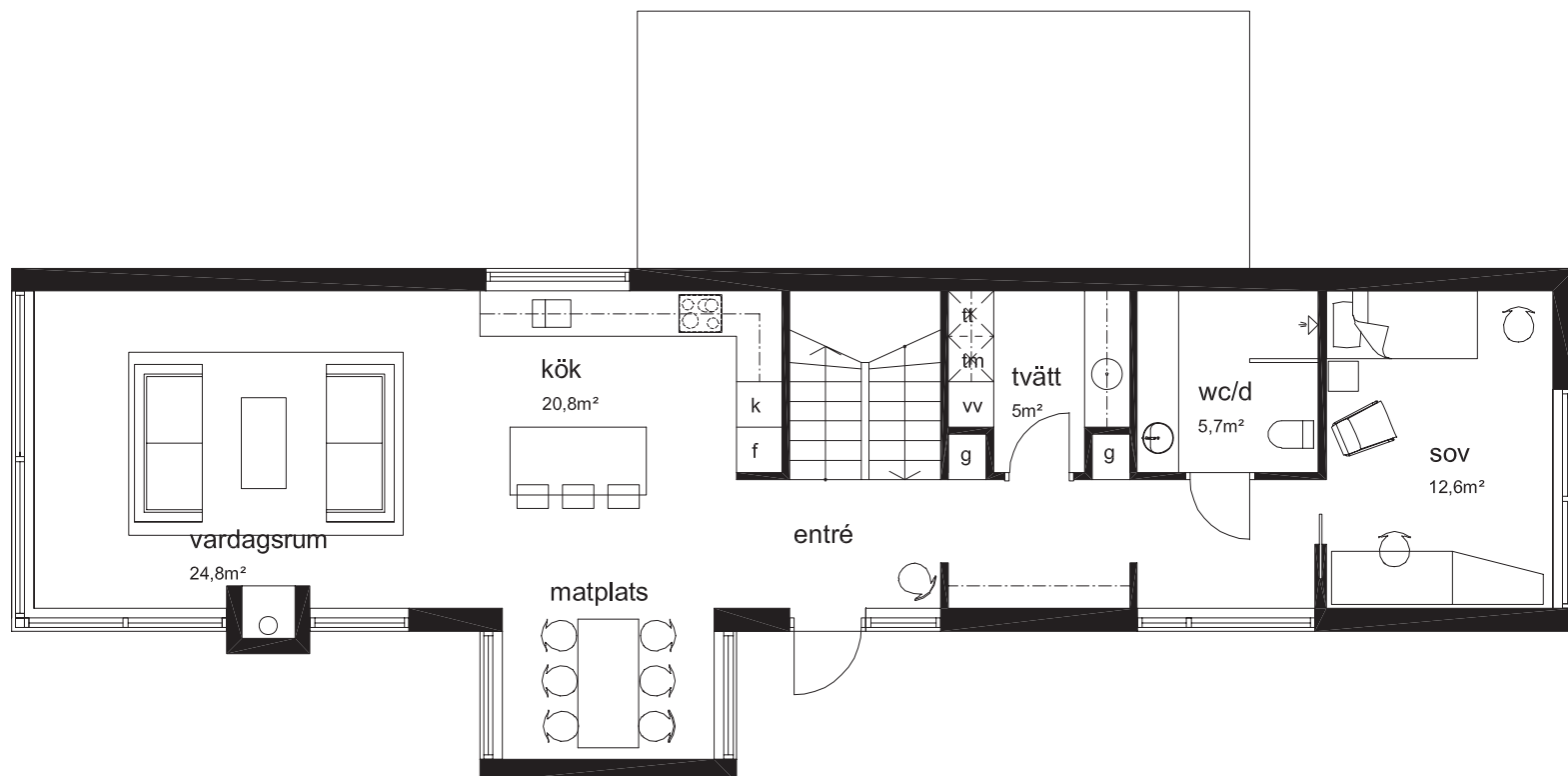
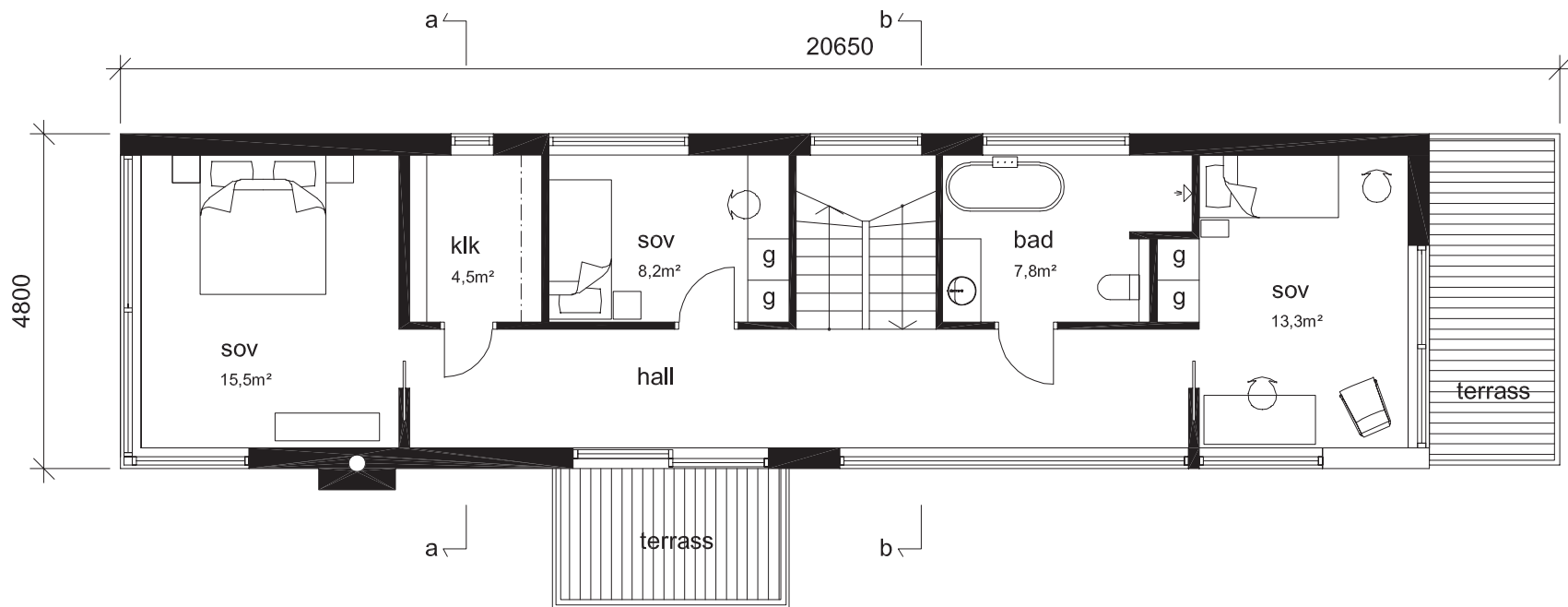

plan 1  
BYA 106m<sup>2</sup>  
BOA 161m<sup>2</sup>  
garage  
BYA 27,5m<sup>2</sup>  
BIA 23m<sup>2</sup>

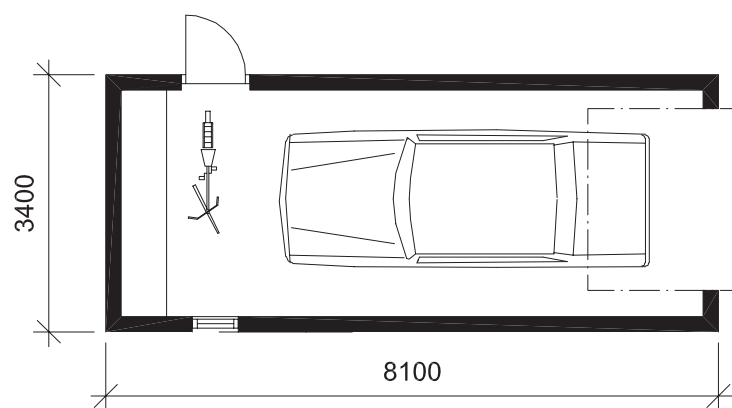

# hus B

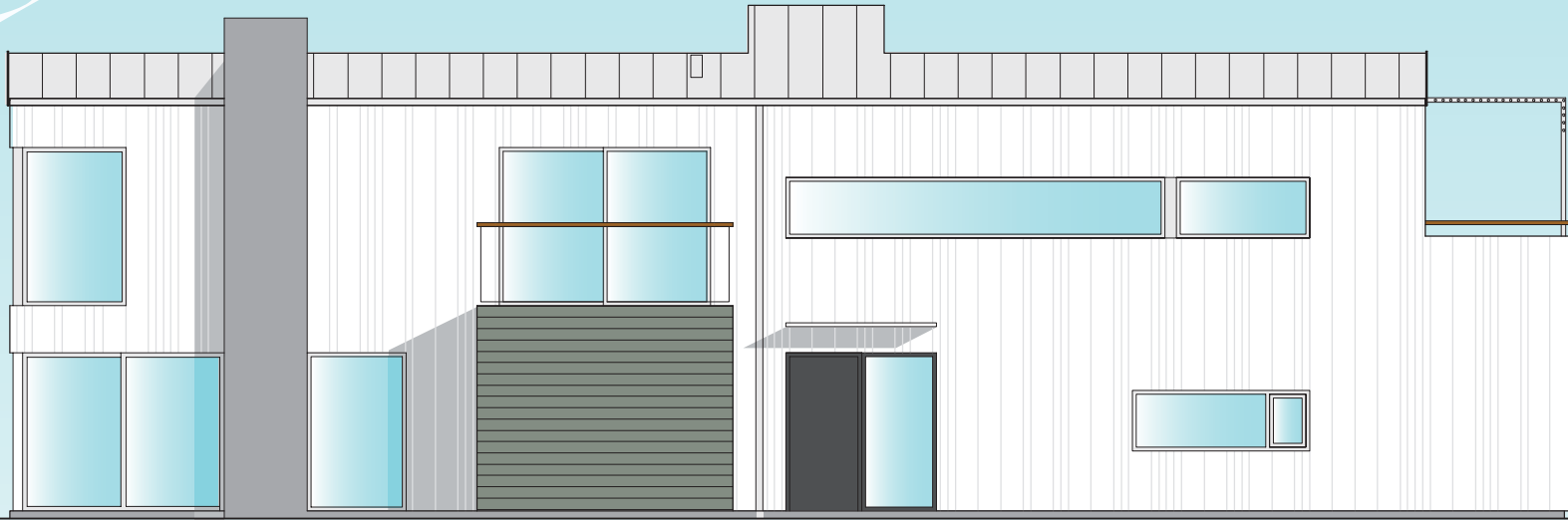

entréfasad

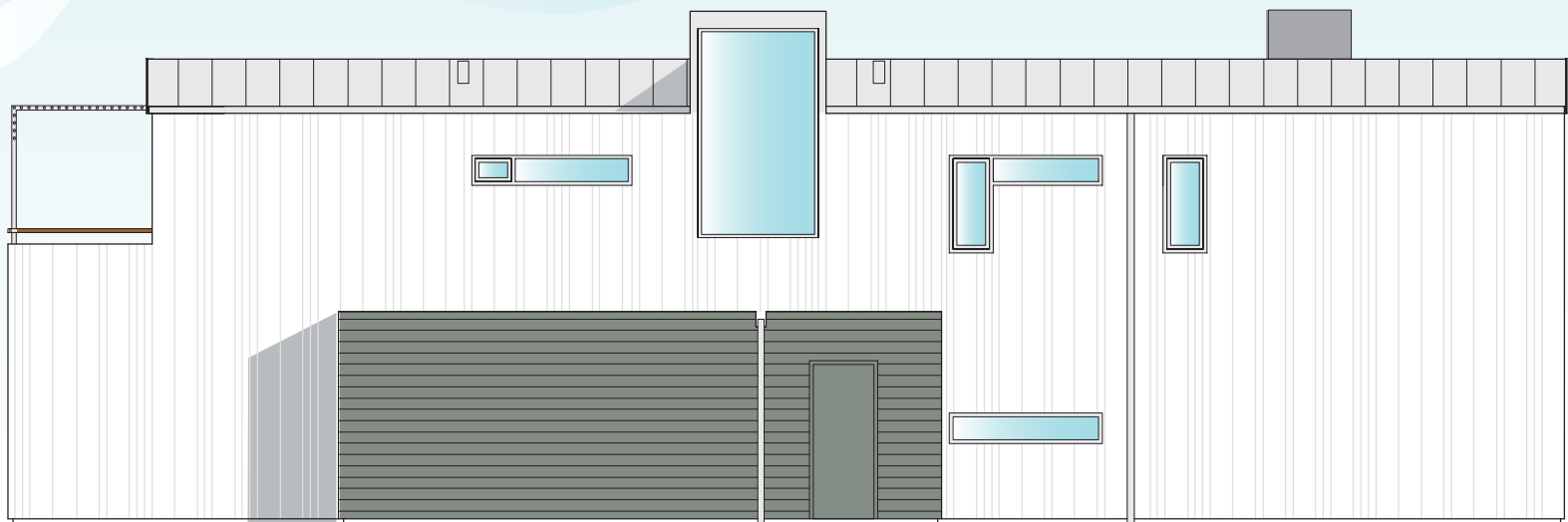

fasad mot granne

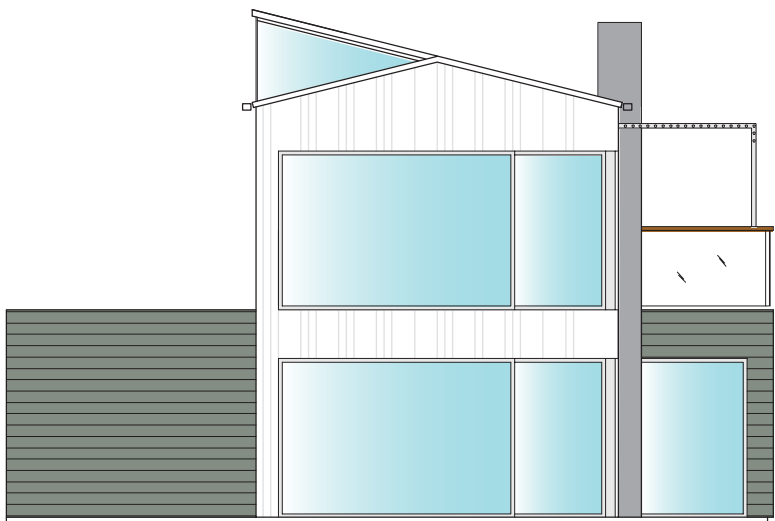

fasad mot trädgård

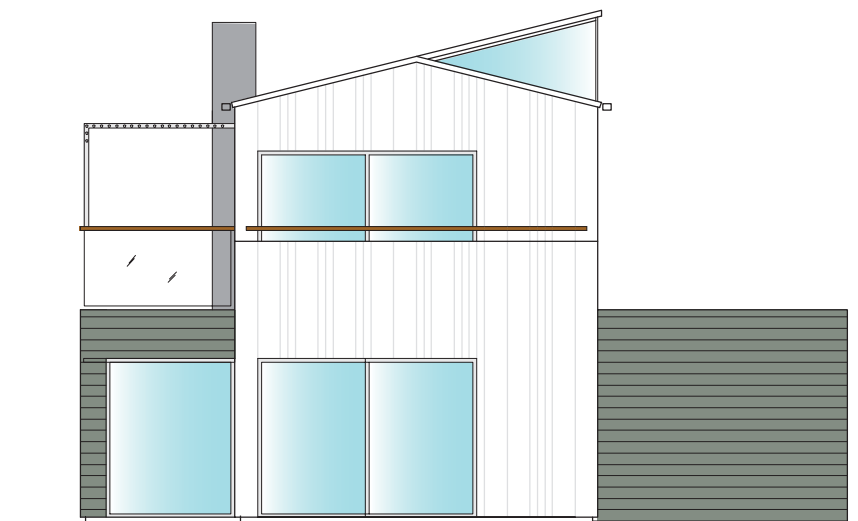

fasad mot gata

# hus C

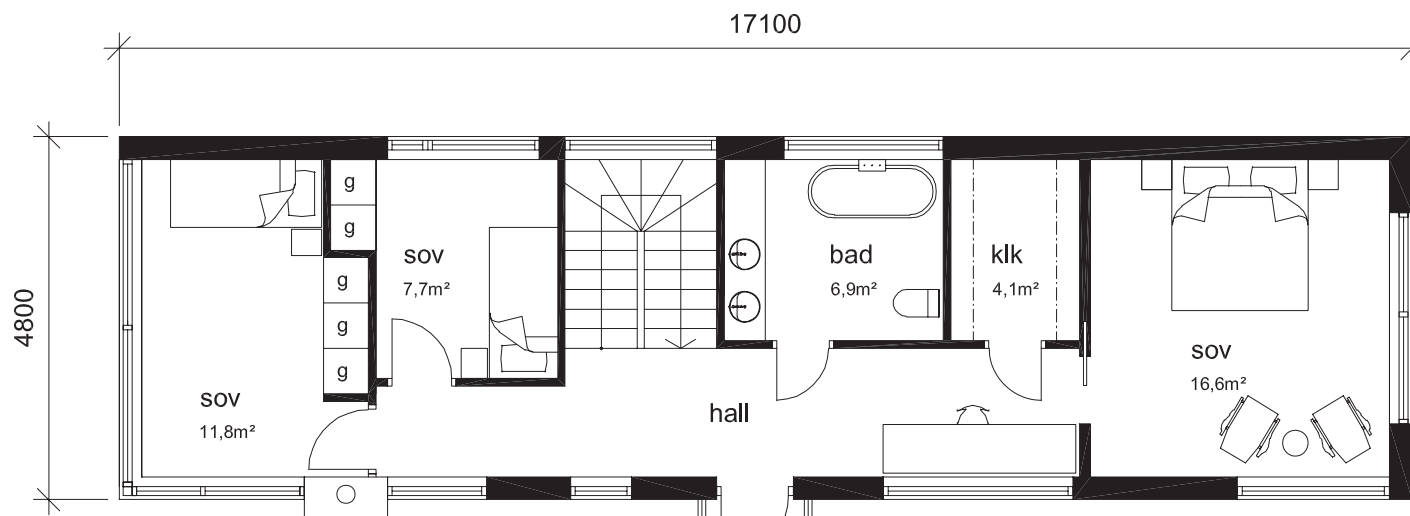

plan 2

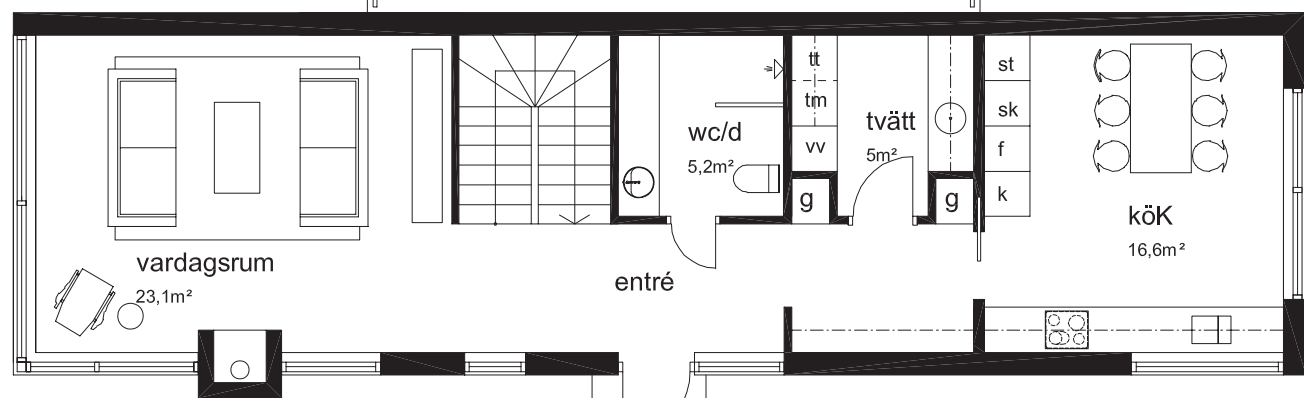

plan 1  
 BYA 82m<sup>2</sup>  
 BOA 133,5m<sup>2</sup>  
 garage  
 BYA 27,5m<sup>2</sup>  
 BIA 23m<sup>2</sup>

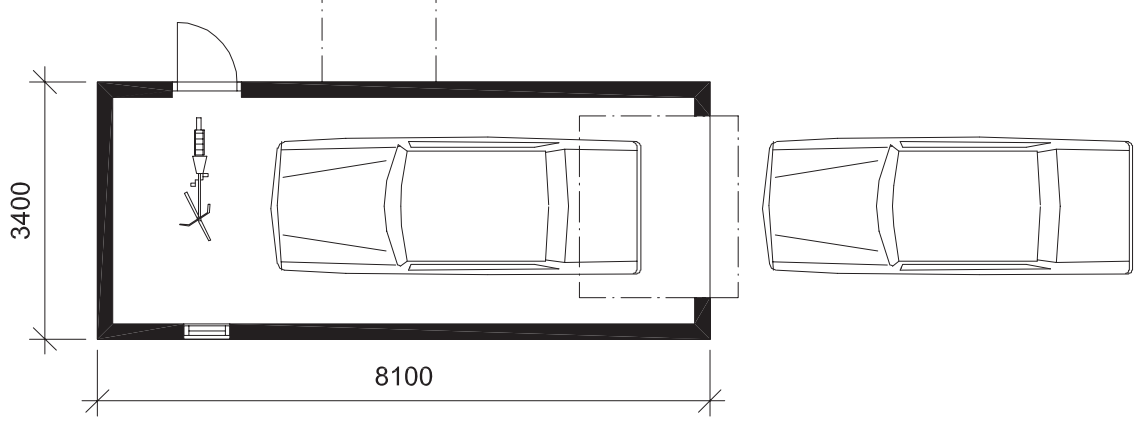

# hus C

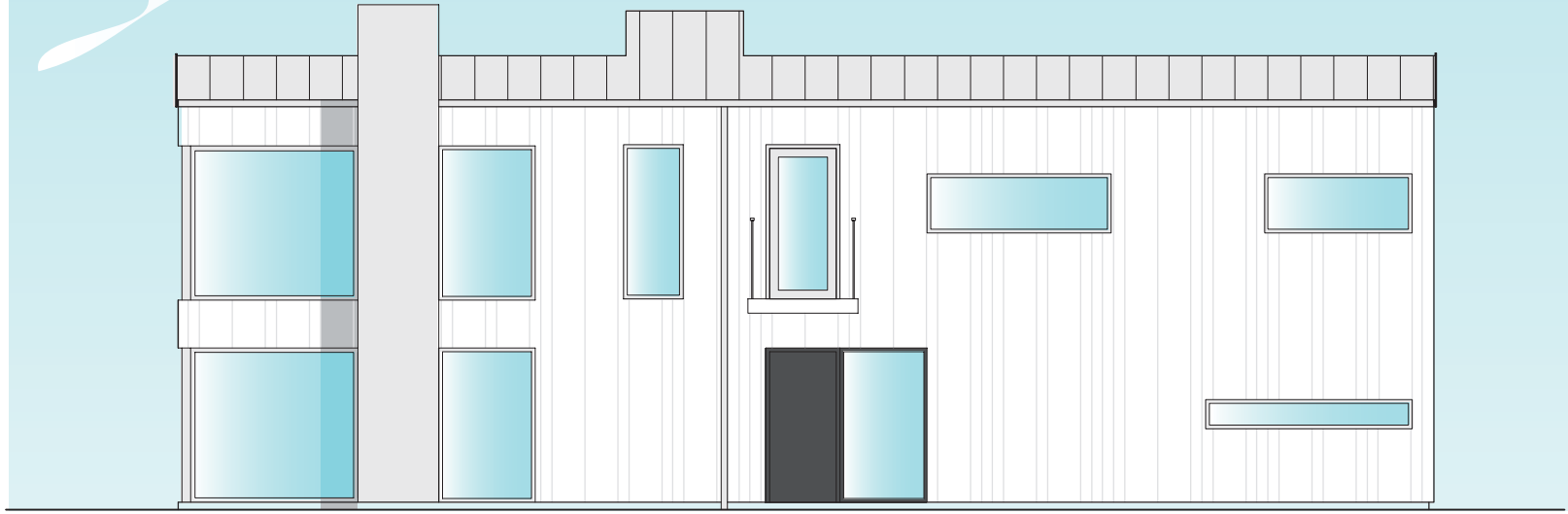

entréfasad

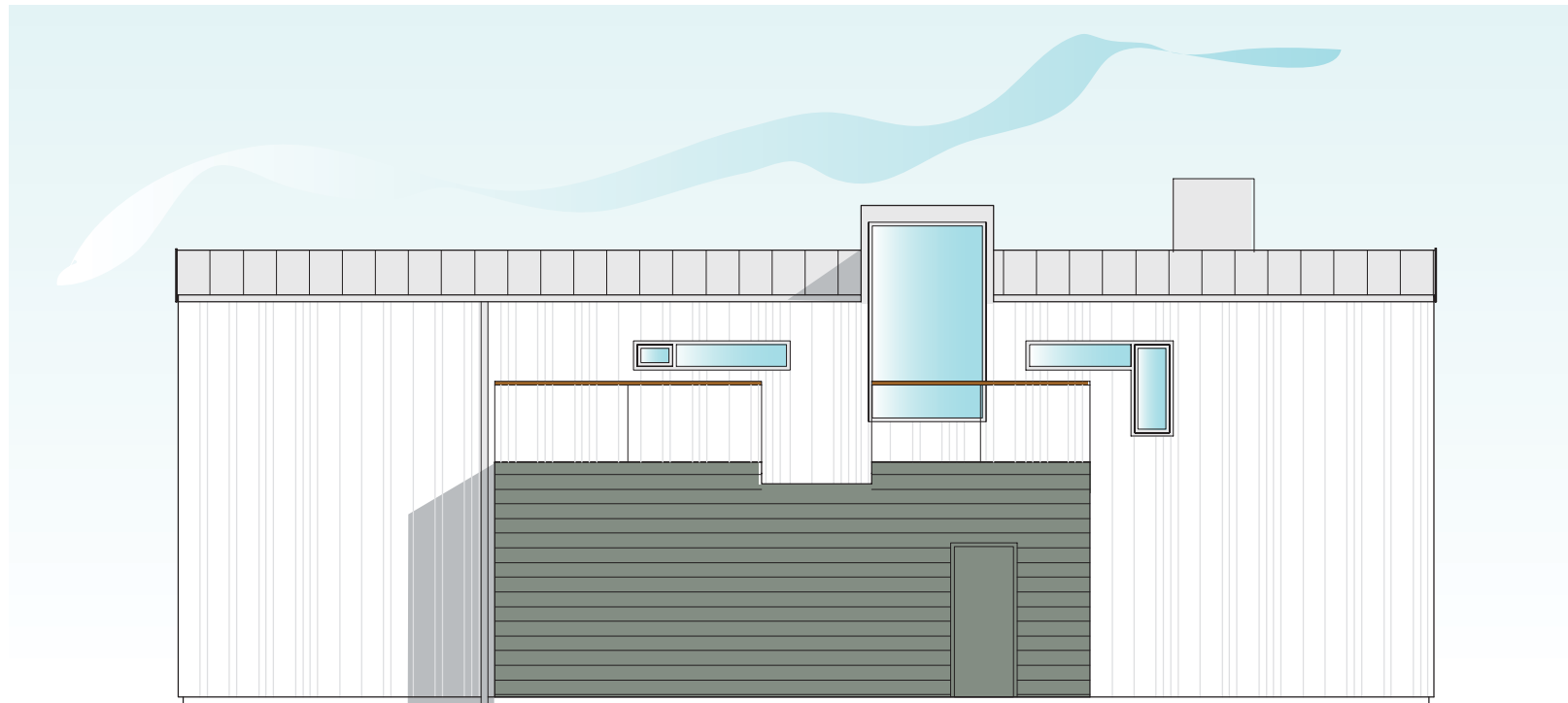

fasad mot granne

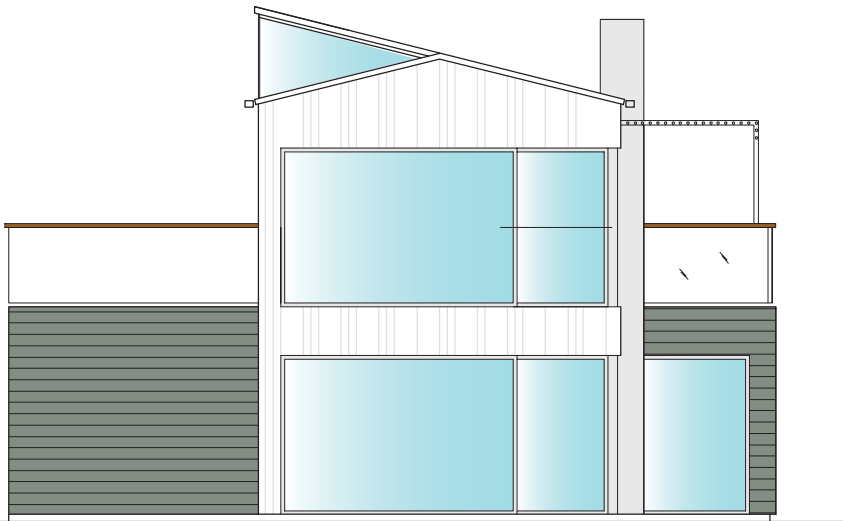

fasad mot trädgård

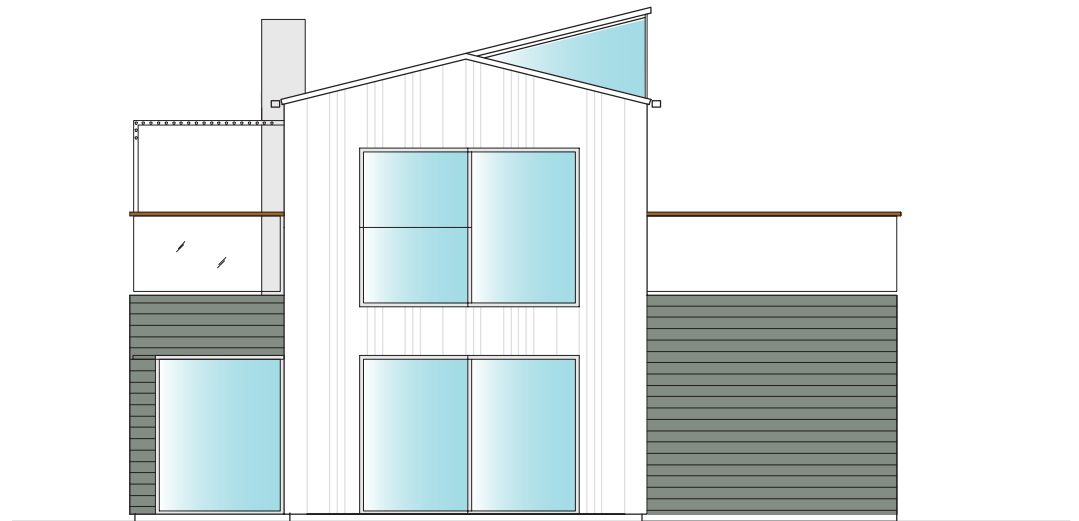

fasad mot gata

# hus E

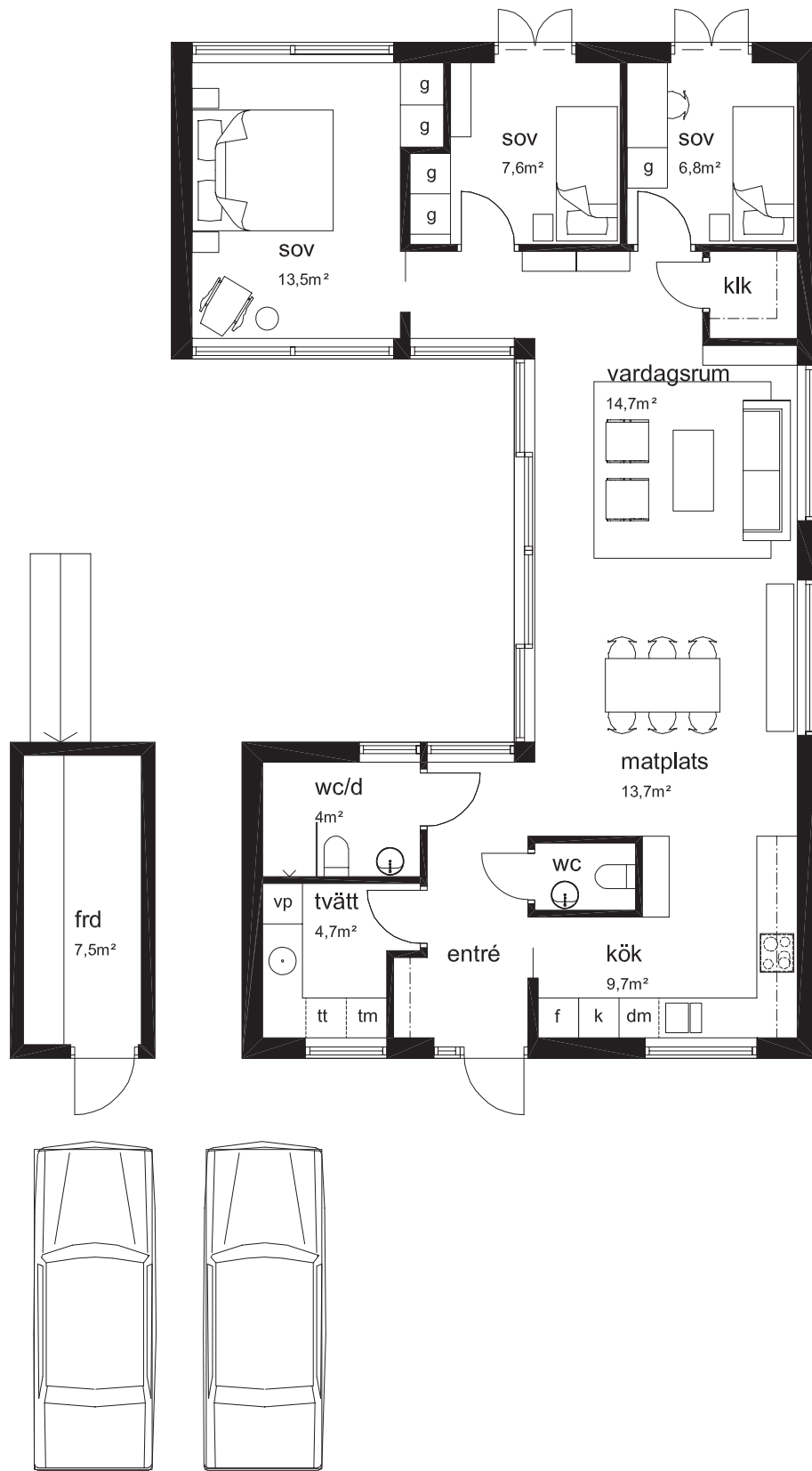

plan 1  
BYA 110m<sup>2</sup>  
BOA 94m<sup>2</sup>  
förråd  
BYA 10m<sup>2</sup>  
BIA 7,5m<sup>2</sup>

# hus E

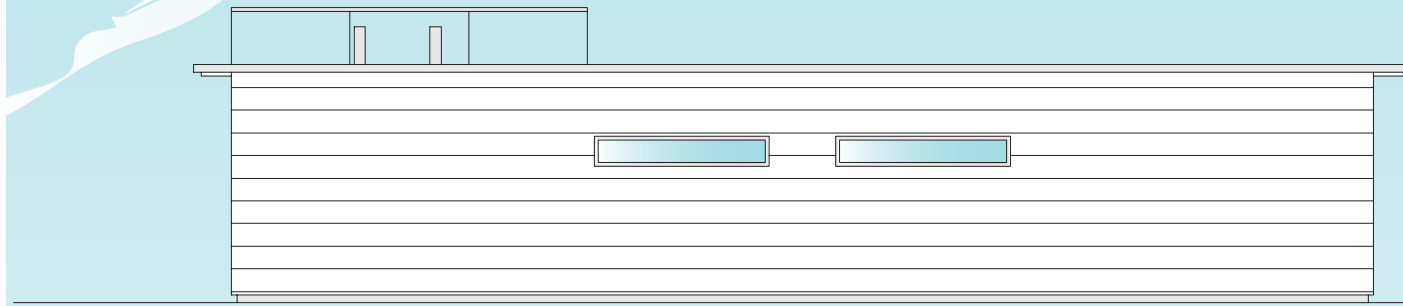

fasad mot öster

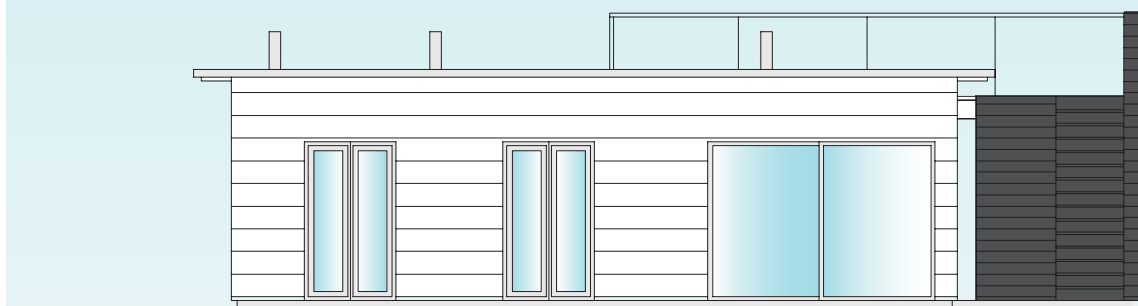

fasad mot norr

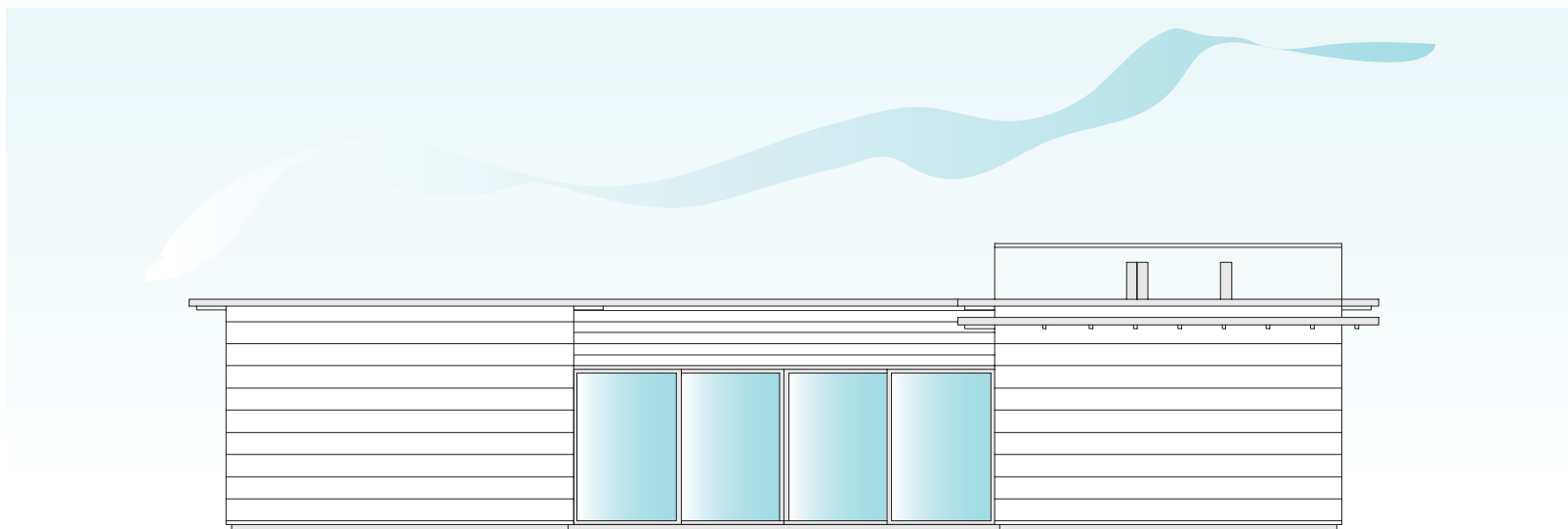

fasad mot väster

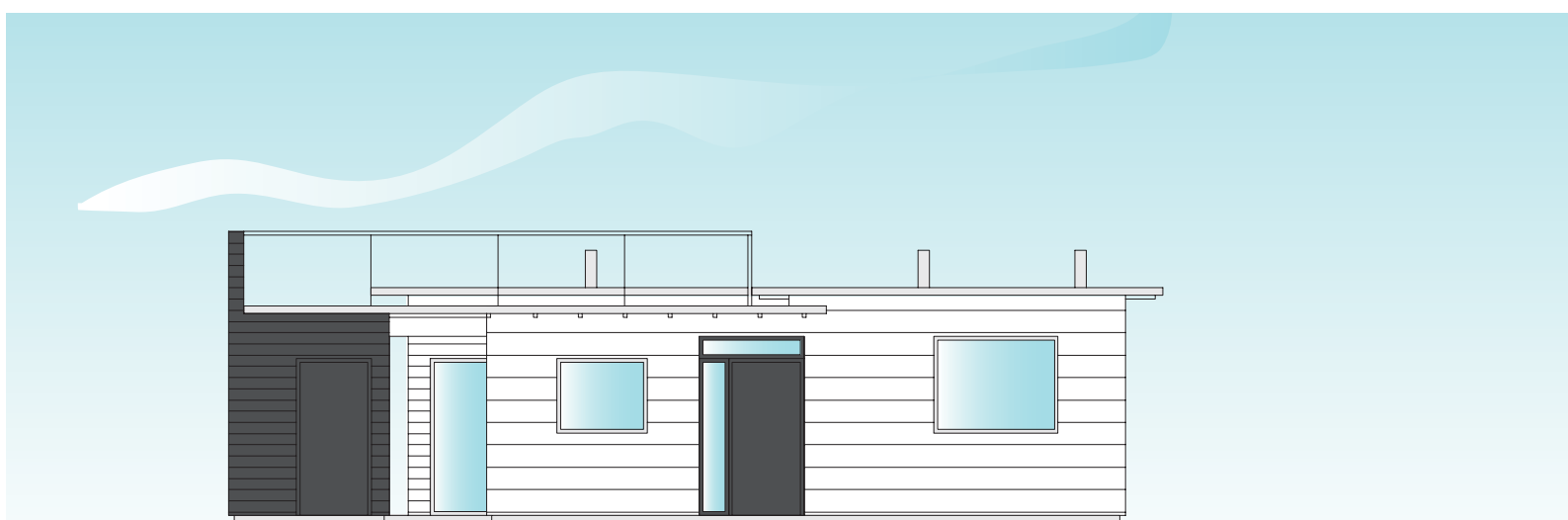

fasad mot söder